

BMG : MAGNETI A BATTERIA

Battery magnets – Aimants a batterie



ITALIANO



ENGLISH



FRANÇAIS

Il Magnete a 12-24V è utilissimo per raccogliere anche i più piccoli pezzi di ferro sia nei cantieri di demolizione sia ove serve movimentare materiali

- utilizza l'energia delle batterie già presenti sul camion/caricatore
- non necessita di generatore elettrico a bordo macchina
- necessario sia alle società di demolizione sia a chi tratta rottami
- utilizzabile su camion raccolta rottami, caricatori per rottame nonché escavatori
- 5 modelli con potenze da 0,5 a 3,0 kW
- per Escavatori/Caricatori/Camion da 6 Ton senza stabilizzatori, o anche meno se si utilizzano gli stabilizzatori.
- Fornito con catena di sollevamento
- il kit di montaggio include anche Scatola di Controllo, Pulsantiera di comando, cavo e spina

12-24V Electromagnet is very helpful to collect also the smallest metal pieces both in scrap recycling sites and handling yards





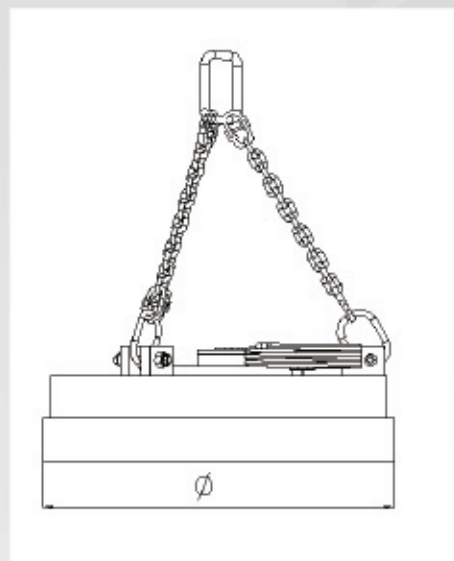

- it uses the energy of the battery already installed on the truck/loader
- it has no need of any electric generator onboard the carrier
- necessary both to demolition companies and to scrapyards
- used on scrap collection trucks, scrap loaders as well as excavators
- 5 models powered from 0,5 up to 3,0 kW
- for Excavators/Loaders/Trucks from 6 Tons without stabilizers, or even less if used with hydraulic stabilizers.
- supplied with Lifting Chain
- mounting set also includes control panel, wired remote control, cable and plugs

L'aimant 12-24V est utile de recueillir même les plus petits morceaux de fer dans les parcs à ferraille

- utilise la batterie déjà sur le camion/chargeur
- ne nécessite pas de générateur électrique à bord de la machine
- nécessaire à la fois aux entreprises de démolition et de casses
- utilisé sur les camions de collecte ferraille, des chargeurs de la ferraille ainsi que les excavatrices
- 5 modèles avec des capacités de 0,5 à 3,0 kW
- pour chargeurs/Camion de 6 Ton sans stabilisateurs, ou encore moins si vous utilisez les stabilisateurs.
- Livré avec chaîne de levage
- kit de montage comprend également un boîtier de commande, panneau de boutons, câble et fiche



Misure metriche - Metric dimensions - Mesures métriques

					Altern. min Amp				
	kg	mm	kw	volt		t	MIN	SUGGERITO SUGGESTED SUGGÈRE	ROTTAME SCRAP FERRAILLE
BMG 65	280	650	0,5	12	50	4	5	150	2.200
BMG 80	490	800	0,7	24	40	6	8	250	2.800
BMG 92	650	920	1,0	24	50	10	14	330	3.650
BMG 105	1020	1050	2,0	24	100	25	30	410	6.000
BMG 125	1400	1250	2,4	24	120	30	36	530	8.000

I prodotti e le caratteristiche tecniche possono subire variazioni senza preavviso

Products and technical specifications may change without notice

Equipments et caracteristiques technique peuvent etre modifiees sans preavis